

Installation Instructions

I - Sheet Number BF69 Rev.A



AUTO VENT SHADE™

Bugflector® - Bugflector II® - Carflector™

For proper installation and best possible fit, please read all instructions BEFORE you begin.
For technical assistance or to obtain missing parts, please call Customer Relations at 1-800-241-7219.

Important Safety Information



- CAUTION - Before driving, ensure that the hood shield is properly anchored to vehicle.
- Do not use automatic "brush-style" car washes.
- Do not use cleaning solvents of any kind.
- Periodically check all components for tightness.

Contents **NOTE:** Actual product may vary from illustration.



Hood shield



Screw x4
(98027)



Washer x4
(98026)



Insert x4
(98025)



Fastener x2
(98030)



Bump On x4
(98024)

Tools Required



Car Wash Supplies



Clean Towel

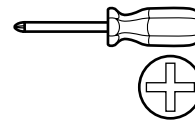

Phillips screw-
driver

Preparation Before Painting / Installation

- A trial fit is recommended to ensure proper positioning and fit.
- Check fit of parts before painting as we will not accept the return of modified or painted parts.
- Wash and dry your vehicle to remove any debris and/or dirt from the installation area.

Installation Steps **NOTE:** Actual application may vary slightly from illustrations.

Raise hood.

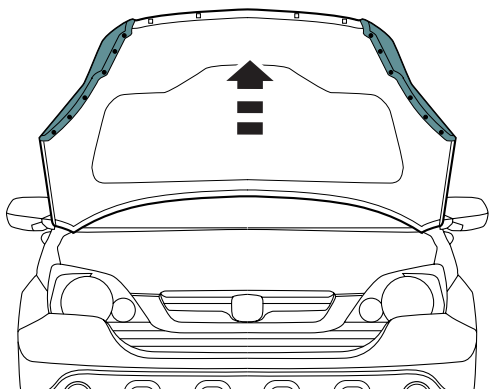

1



Locate (4) square holes on the underside of hood. Clean the area around these with a soft cloth. Install (1) insert in each square hole

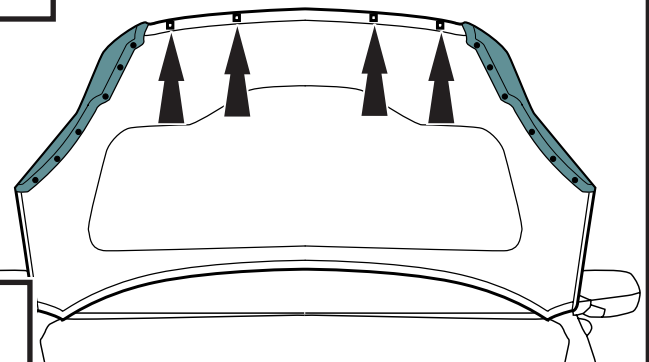

2

Installation Steps

NOTE: Actual application may vary slightly from illustrations.

Locate (2) rubber trim pieces on the underside of hood. On each side, locate and remove the retainer that is located second from the front.

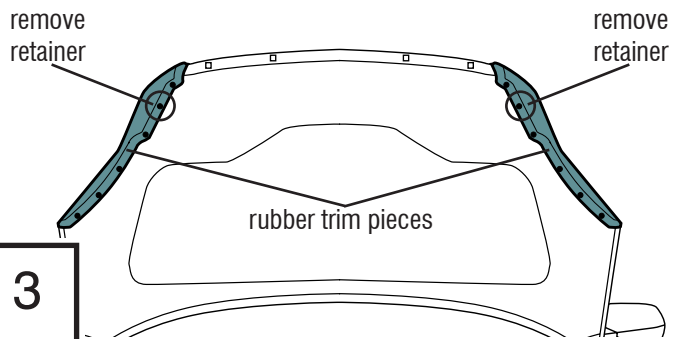

Center part on front edge of hood and align holes. Slide the outboard flanges **UNDER** the rubber trim pieces.

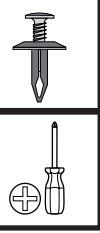
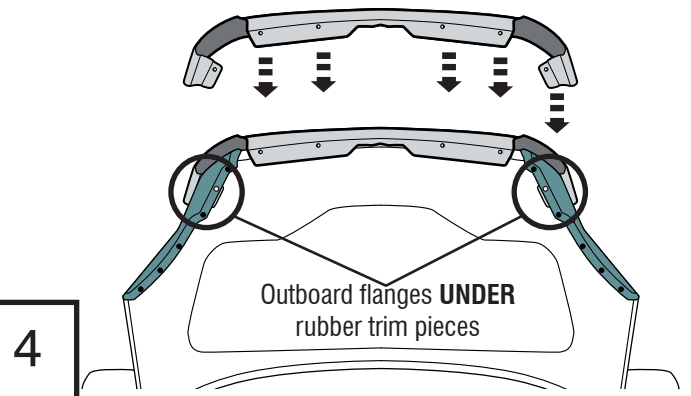

Insert a fastener through rubber trim piece and hood shield, and into hood on each **OUTBOARD** flange. Tighten fastener.

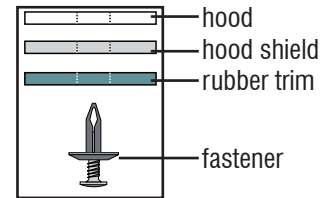
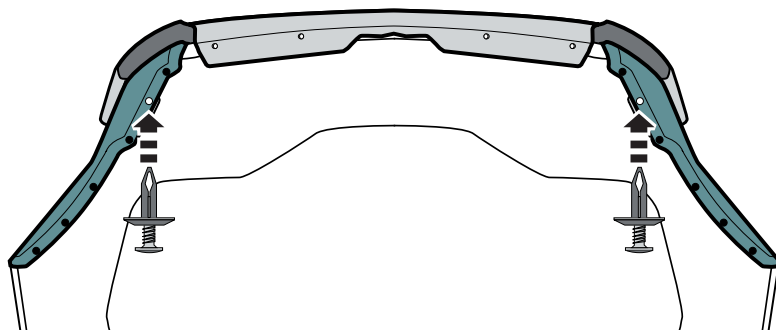

Place a washer over a screw and insert through hood shield and into hood. Repeat for remaining holes. Tighten screws.

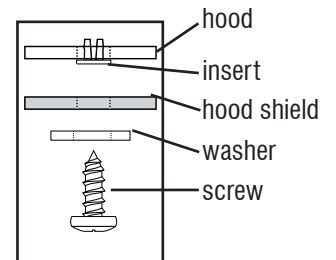
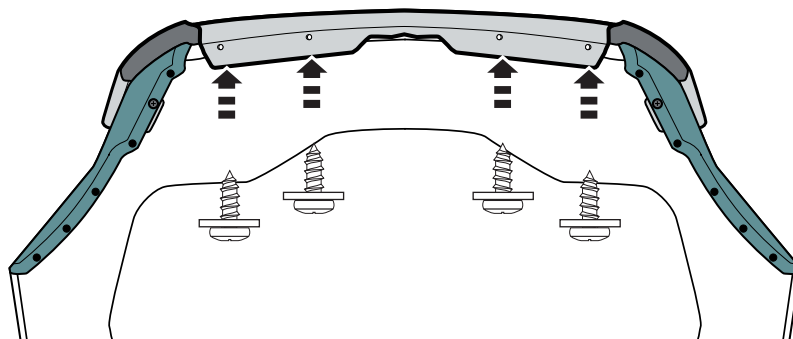

Close Hood.

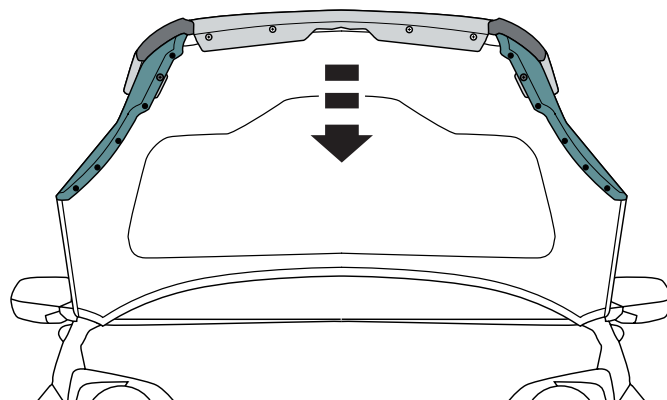



Apply bump ons to surface of hood.

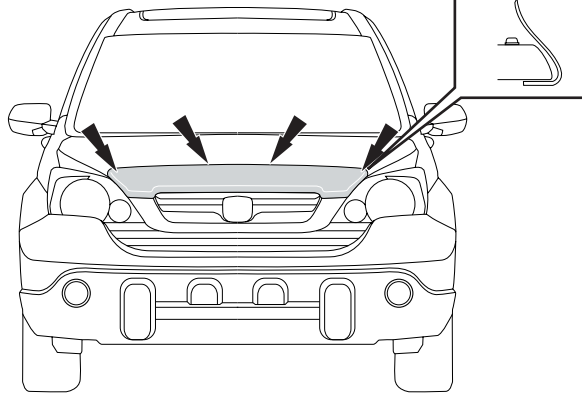

8

Care and Cleaning

- Wash only with mild soap & dry with a clean cloth.

Congratulations!

You have purchased one of the many quality Auto Ventshade™ branded products offered by Lund International, Inc. We take the utmost pride in our products and want you to enjoy years of satisfaction from your investment. We have made every effort to ensure that your product is top quality in terms of fit, durability, finish and ease of installation.



AUTO VENTSHADE™

Lund International, Ventshade Accessories Division
655 Raco Drive, Lawrenceville, GA 30045
800-241-7219 • Fax 770-339-5839 • Visit us at lundinternational.com



© 2006 Lund International, Inc. All rights reserved.
Auto Ventshade™, the Auto Ventshade™ logo and the AVS™ logo are trademarks of Lund International, Inc.





AUTO VENTSHADE™

Bugflector® - Bugflector II® - Carflector™

Pour obtenir une installation correcte et le meilleur ajustement possible, lire toutes les instructions AVANT de commencer.

Pour toute assistance technique ou obtention de pièces manquantes, appeler le service des relations avec la clientèle au 1-800-241-7219.

Informations importantes concernant la sécurité



- ATTENTION – Avant de conduire, s'assurer que le pare-insectes est solidement assujéti sur le véhicule.
- Ne pas utiliser les stations de lavage de voitures à brosses.
- Ne pas utiliser de solvants.
- Vérifier régulièrement le serrage des composants.

Contenu

REMARQUE : Le produit peut être différent de celui représenté sur l'illustration.



Pare-insectes



Vis (4)
(98027)



Rondelle (4)
(98026)



Insertions (4)
(98025)



Attache (2)
(98030)



Butoirs (4)
(98024)

Outils nécessaires



Fournitures pour lavage de voiture

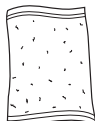

Serviette propre

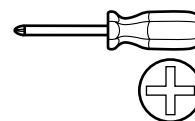

Tournevis cruciforme

Préparation pour la peinture/l'installation

- Il est recommandé de procéder à un essai pour s'assurer que le positionnement et l'ajustement sont corrects.
- Vérifier l'ajustement des pièces avant peinture, car nous n'acceptons pas le retour de pièces modifiées ou peintes.
- Laver le véhicule pour éliminer toute poussière et tous débris.
- Sécher le capot avec une serviette propre.

Étapes d'installation

REMARQUE : La méthode d'application peut être légèrement différente de celle représentée par les illustrations.

Soulever le capot.

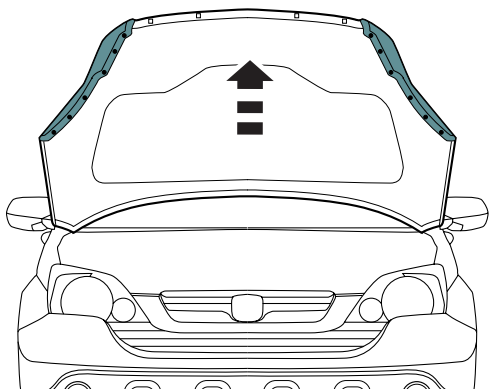

1



Localiser les 4 trous carrés du dessous du capot. Nettoyer le pourtour des trous avec un chiffon doux. Installer 1 insert dans chaque trou carré.

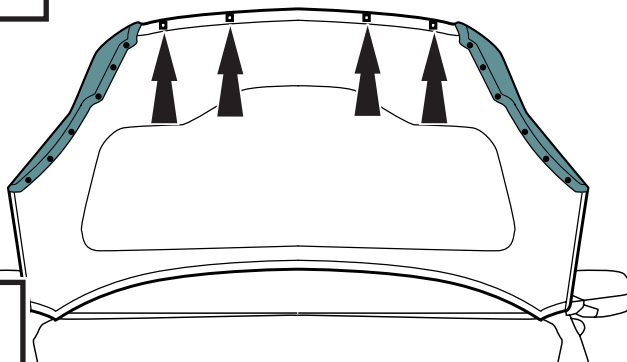

2

Étapes d'installation

REMARQUE : La méthode d'application peut être légèrement différente de celle représentée par les illustrations.

Localiser les 2 morceaux de garniture en caoutchouc du dessous du capot. De chaque côté, localiser et retirer la retenue qui est la deuxième en partant de l'avant.

Retirer la retenue

Retirer la retenue

Morceaux de garniture en caoutchouc

3

Centrer la pièce sur le devant du capot et aligner les trous. Faire glisser les rebords extérieurs **SOUS** les morceaux de garniture en caoutchouc.

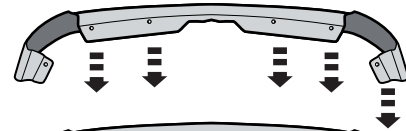

Rebords extérieurs **SOUS** les morceaux de garniture en caoutchouc

4



Insérer une fixation au travers du morceau de garniture en caoutchouc et du pare-insectes, puis dans le capot, sur chaque rebord **EXTÉRIEUR**. Resserrer la fixation.

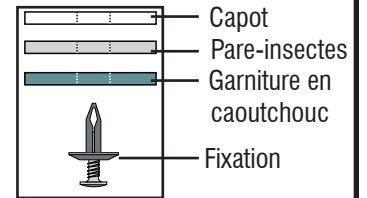
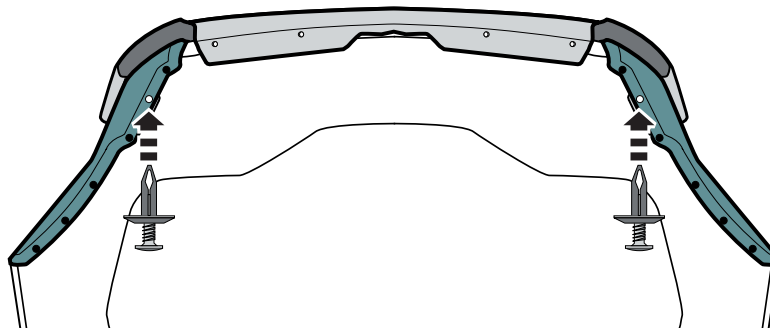
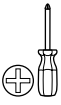

5

REMARQUE : NE PAS TROP SERRER



Placer une rondelle au-dessus d'une vis et les insérer au travers du pare-insectes et dans le capot. Répéter la procédure pour les autres trous. Serrer les vis.

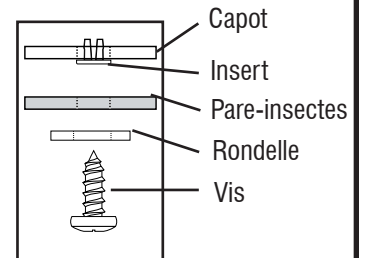
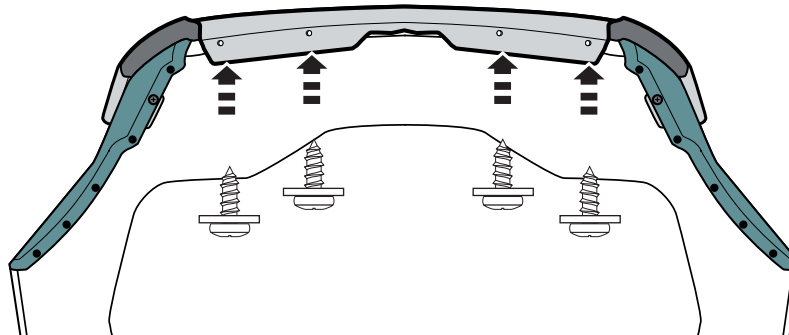

6

REMARQUE : NE PAS TROP SERRER

Fermer le capot.

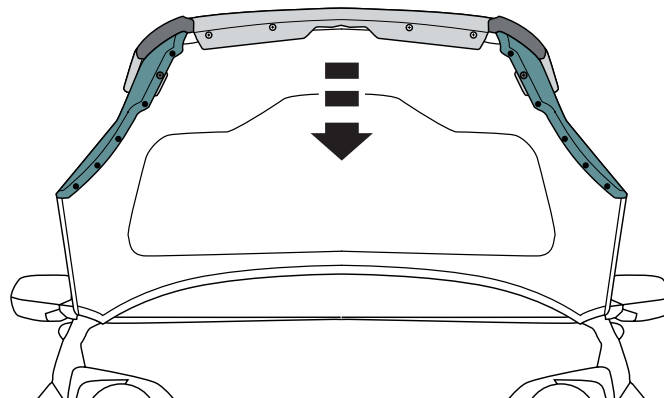

7



Appliquer les butoirs sur le capot.

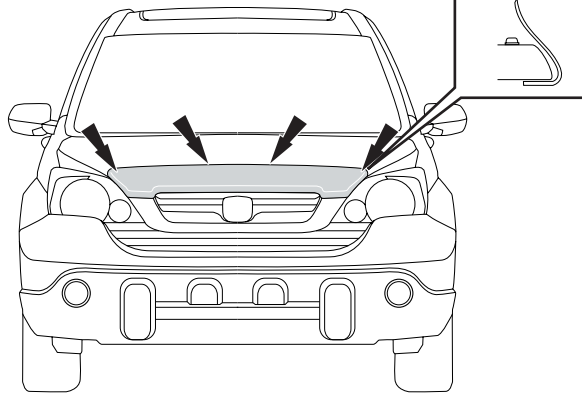

8

Entretien et nettoyage

- Laver exclusivement avec de l'eau savonneuse et sécher avec un chiffon propre.

Félicitations !

Vous avez acheté l'un des nombreux produits de qualité Auto Ventshade™ offerts par Lund International, Inc. Nous sommes extrêmement fiers de nos produits et souhaitons que vous tiriez des années de satisfaction de votre investissement. Nous avons pris toutes les mesures nécessaires pour assurer que ce produit est d'une qualité supérieure en ce qui concerne l'ajustement, la durabilité, la finition et la facilité d'installation.



AUTO VENTSHADE™

Lund International, Ventshade Accessories Division
655 Raco Drive, Lawrenceville, GA 30045, USA
800-241-7219 • Fax 770-339-5839 • Visitez notre site lundinternational.com



© 2006 Lund International, Inc. Tous droits réservés.
Auto Ventshade™, le logo Auto Ventshade™ et le logo AVS™ sont des marques déposées de Lund International, Inc.





AUTO VENT SHADE™

Bugflector® - Bugflector II® - Carflector™

Para una instalación adecuada y el mejor ajuste posible, lea todas las instrucciones ANTES de comenzar. Si desea recibir asistencia técnica u obtener piezas faltantes, llame al Servicio al cliente al 1-800-241-7219.

Información importante de seguridad



- PRECAUCIÓN - Antes de conducir, asegúrese de que la cubierta para capó esté correctamente anclada al vehículo.
- No utilice servicios automáticos de limpieza de vehículos que utilizan cepillos.
- No utilice limpiadores al solvente de ningún tipo.
- Compruebe periódicamente que todos los componentes estén ajustados.

Contenido AVISO: El producto real puede variar con respecto a las ilustraciones.



Cubierta para capó



Tornillo
x 4
(98027)



Aramidela
x4
(98026)



Rellenos
x4
(98025)



Sujetador
x2
(98030)



Soporte
x 4
(98024)

Herramientas necesarias



Equipo de limpieza de
vehículos



Toalla limpia

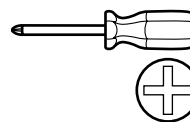

Destornillador de cabeza Phillips

Preparación antes de pintar o instalar

- Se recomienda realizar un ajuste de prueba para asegurar el posicionamiento y ajuste correctos.
- Compruebe que las piezas se ajusten correctamente antes de pintarlas, ya que no aceptaremos la devolución de piezas modificadas o pintadas.
- Lave el capó del vehículo para quitar los desechos y la suciedad.
- Seque el capó con una toalla limpia.

Pasos de instalación AVISO: La colocación real puede variar con respecto a las ilustraciones.

Levante el capó.

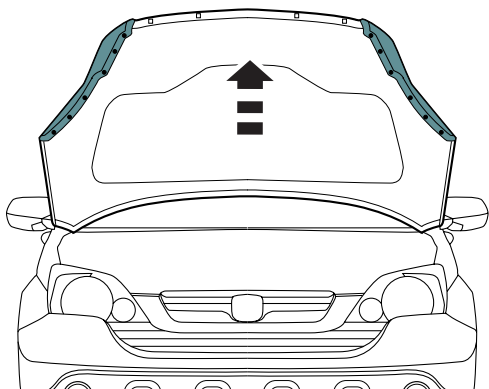

1



Ubique los (4) orificios cuadrados en la parte inferior del capó. Limpie el área alrededor de los orificios con un paño suave. Instale (1) aplico en cada orificio cuadrado

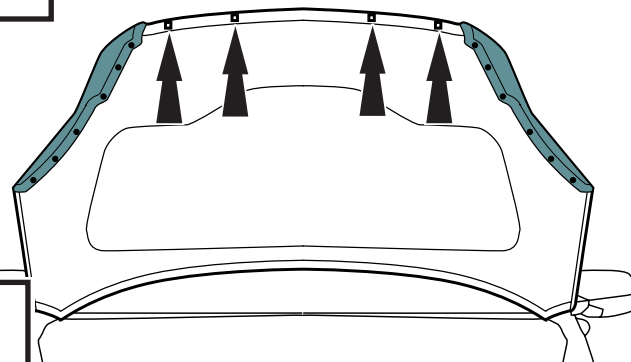

2

Pasos de instalación **AVISO:** La colocación real puede variar con respecto a las ilustraciones.

Ubique las (2) bandas de goma en la parte inferior del capó.
En cada lado, ubique y quite el retenedor que se encuentra situado en segundo lugar con respecto a la parte frontal.

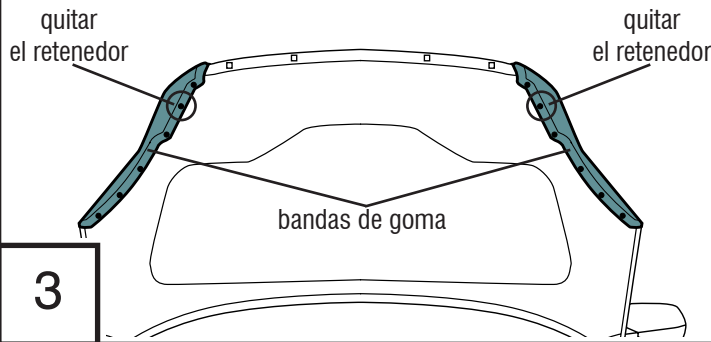

Centre la pieza en el borde delantero del capó y alinee los orificios.
Deslice los rebordes exteriores **DEBAJO** de las bandas de goma.

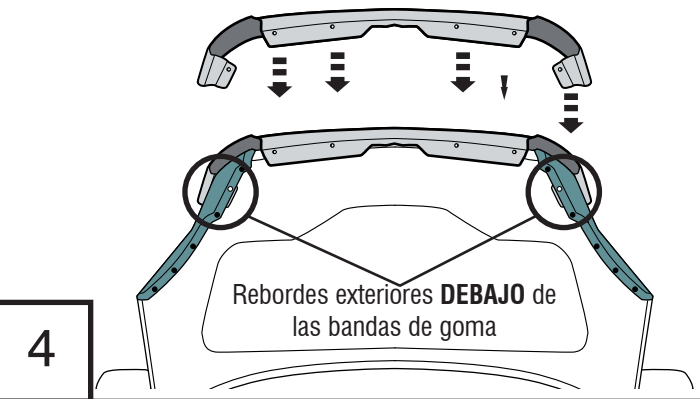

Coloque un sujetador a través de la banda de goma y la cubierta para capó, y dentro del capó en cada reborde **EXTERIOR**.
Ajuste el sujetador.

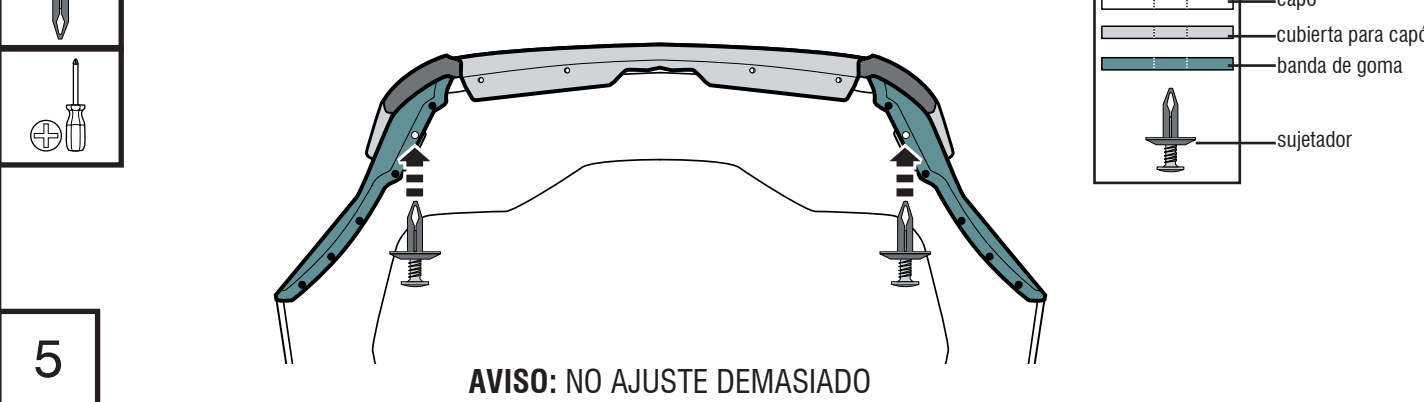

Coloque una arandela en un tornillo e insértelo a través de la cubierta para capó y el aplique hasta introducirlo en el capó.
Repita el procedimiento en los orificios restantes. Ajuste los tornillos.

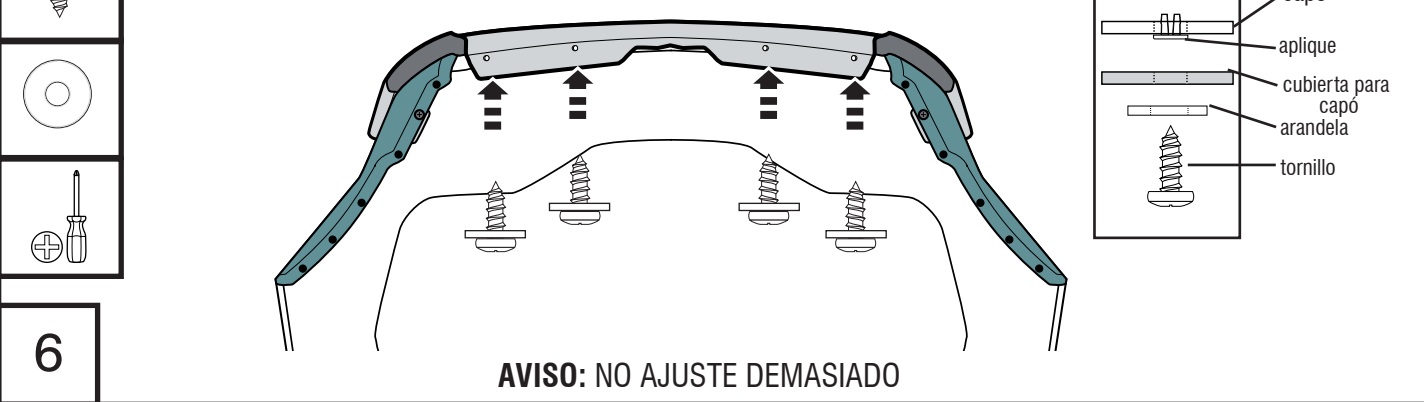

Cierre el capó.

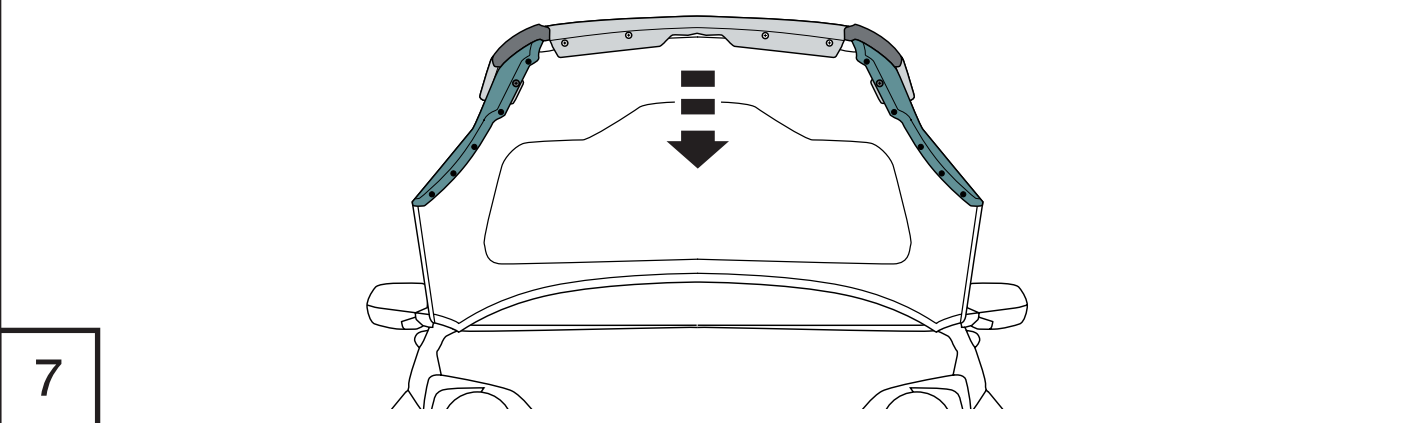



Coloque los soportes en la superficie del capó.

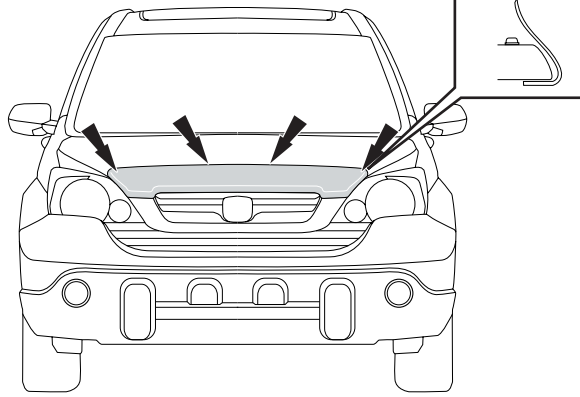

8

Cuidado y limpieza

- Limpie solamente con agua jabonosa tibia y seque con un paño limpio.

Felicidades

Usted ha comprado uno de los tantos artículos de calidad de Auto Ventshade™ ofrecidos por Lund International, Inc. Nuestros productos son nuestro mayor orgullo. Deseamos que disfrute de años de satisfacción con su inversión. Hemos realizado todos los esfuerzos para asegurarnos de que su producto sea de la mejor calidad en cuanto a ajuste, durabilidad, acabado y facilidad de instalación.



AUTO VENTSHADE™

Lund International, Ventshade Accessories Division

655 Raco Drive, Lawrenceville, GA 30045

800-241-7219 • Fax 770-339-5839 • Visite nuestro sitio Web: lundinternational.com



© 2006 Lund International, Inc. Todos los derechos reservados.
™ Auto Ventshade™, el logo de Auto Ventshade™ y el logo de AVS™ son marcas comerciales de Lund International, Inc.

